

Highest Quality

Gas Chlorination Systems



Application: Gas chlorination systems are used for water disinfection and other purposes in a variety of applications. Compared to other disinfection methods, chlorine offers the advantage of a stable and long lasting residual that can remain in the water protecting it from recontamination after treatment. Among chlorination methods, chlorine gas is the most economical and the equipment is also the most reliable and easy to operate. Some of the most common applications for large scale gas chlorination systems are surface water treatment plants, waste water treatment plants, and cooling towers for power plants, oil refineries, etc...Gas chlorination systems are also used in a variety of industrial, mining, and agricultural applications.

Purpose: Regardless of the application, the gas chlorination system will be required to inject chlorine gas into the process water at one or more locations (with the goal of achieving a desired level of residual chlorine to the process water). Different applications have different requirements for the residual chlorine concentration depending on the water quality and the application. Chlorine residual is quantified in units of parts per million (PPM or mg/L). In order to maintain a constant residual in the water, as the process water flow rate increases and decreases the chlorine feed rate should proportionally increase and decrease. It also must be realized that a certain amount of chlorine will be consumed in reactions upon entering the process water and that this amount of chlorine will not be available as chlorine residual. The amount of chlorine residual consumed in this way is sometimes referred to as the chlorine demand of the water (in units of PPM). The chlorine demand is different for every process water and can range from close to zero to over 20 PPM. Keeping the above points in mind, the following equation is used to determine the required chlorine gas feed rate for each chlorine gas injection point:

$$\text{[Process Water Flow (m}^3\text{/hr)]} \times \text{[Dosage (PPM)]} = \text{Chlorine Gas Feed Rate (gr/hr)}$$

NOTES:

$$\text{Water Flow (m}^3\text{/hr)} = \text{Process water flow rate in cubic meters per hour}$$

$$\text{Dosage (PPM)} = \text{[chlorine demand]} + \text{[desired chlorine residual]}$$

System Example (Surface Water Treatment Plant): Figure 1 shows a very basic schematic of a surface water treatment plant. The diagram shows three chlorine gas injection points. One gas chlorination system with three injection points is shown in the diagram. The gas chlorination system can be broken down into three sections as indicated in Figure 1.

Figure 1: Surface Water Treatment Plant (Example)

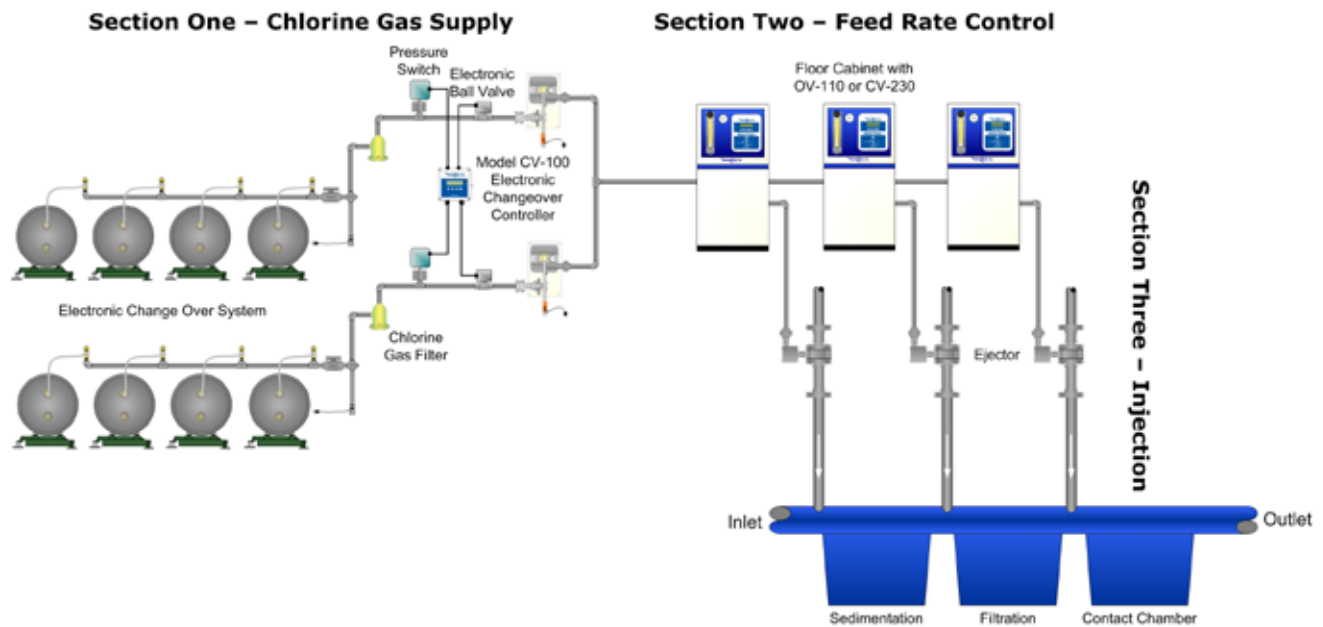

Typical: Gas chlorination systems follow a modular design principle. As seen in Figure 1 above, the gas chlorination equipment can be divided into three sections starting from the chlorine gas containers and ending at the ejectors as follows:

- (1) **Chlorine Gas Supply** – This part of the system is designed to provide an uninterrupted supply of chlorine gas flowing under vacuum.
- (2) **Feed Rate Control** – In this section, equipment is provided to monitor and control the feed rate of chlorine gas to each injection point. The feed rate control can be manual or automatic based on 4-20mA input signals from water flow meters or residual chlorine analyzers. (Step feed control based on switch inputs is also available.)
- (3) **Ejector System** – The ejectors create the vacuum that operates the system in an on-off fashion. The chlorine gas enters the water inside the ejector and then the chlorinated water solution is piped to the injection point where it is delivered to the main process water flow.

Safety and monitoring equipment such as gas leak detectors, residual chlorine analyzers, container scales, emergency valve closure systems, emergency repair kits, and chlorine leak absorption systems (scrubber systems) are also available from Hydro Instruments and our sales representatives.

There are many options available for designers to select. This document will review general options for each stage of the system. Please also refer to additional Hydro Instruments product literature for additional details.

Figure 2 is a diagram depicting several of the more common equipment configurations for each part of the gas chlorination system. This figure shows three different options for the chlorine gas supply section and four different options for the feed rate measurement and control section of a system.

Note that one chlorine gas supply section is frequently used to supply chlorine gas to multiple injection points.

Figure 2: System Layout Options

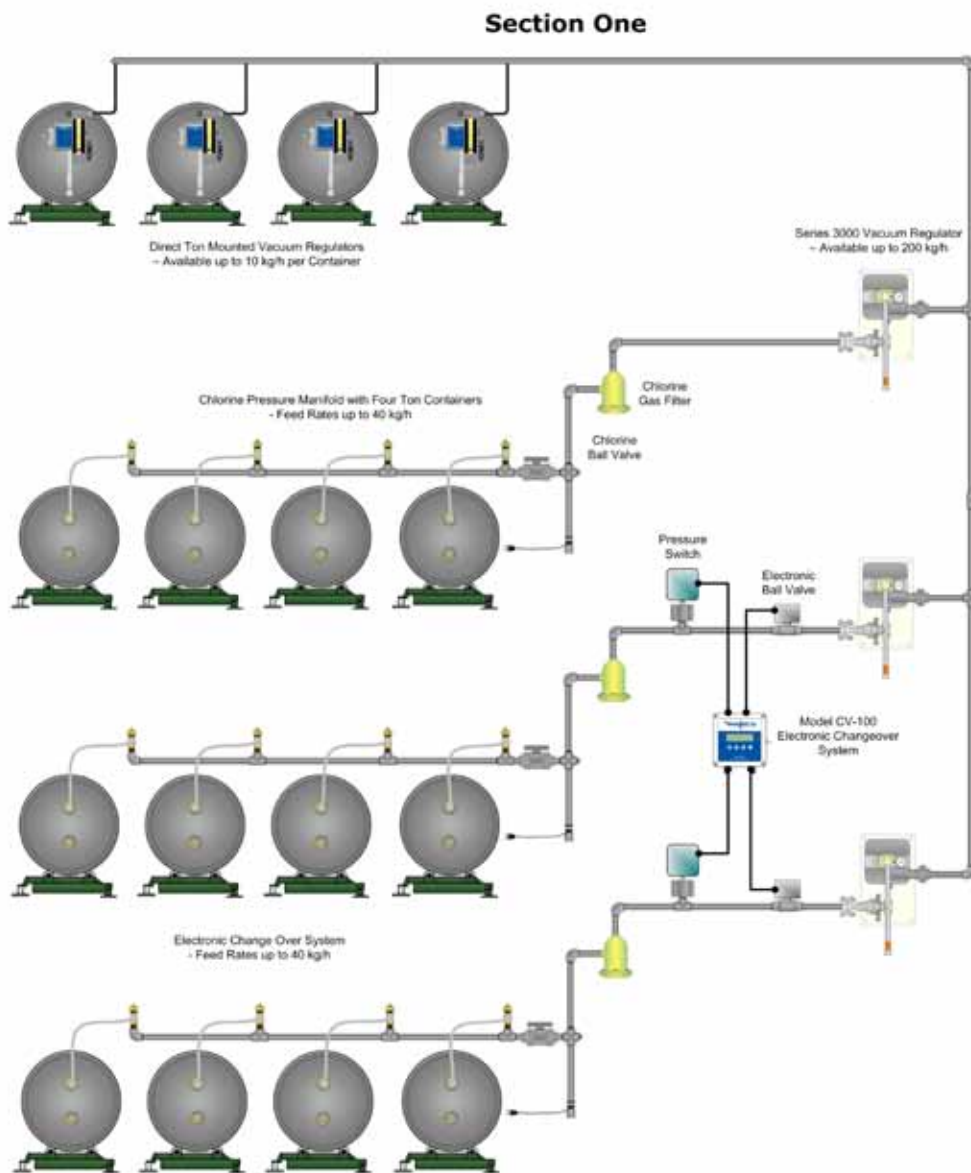
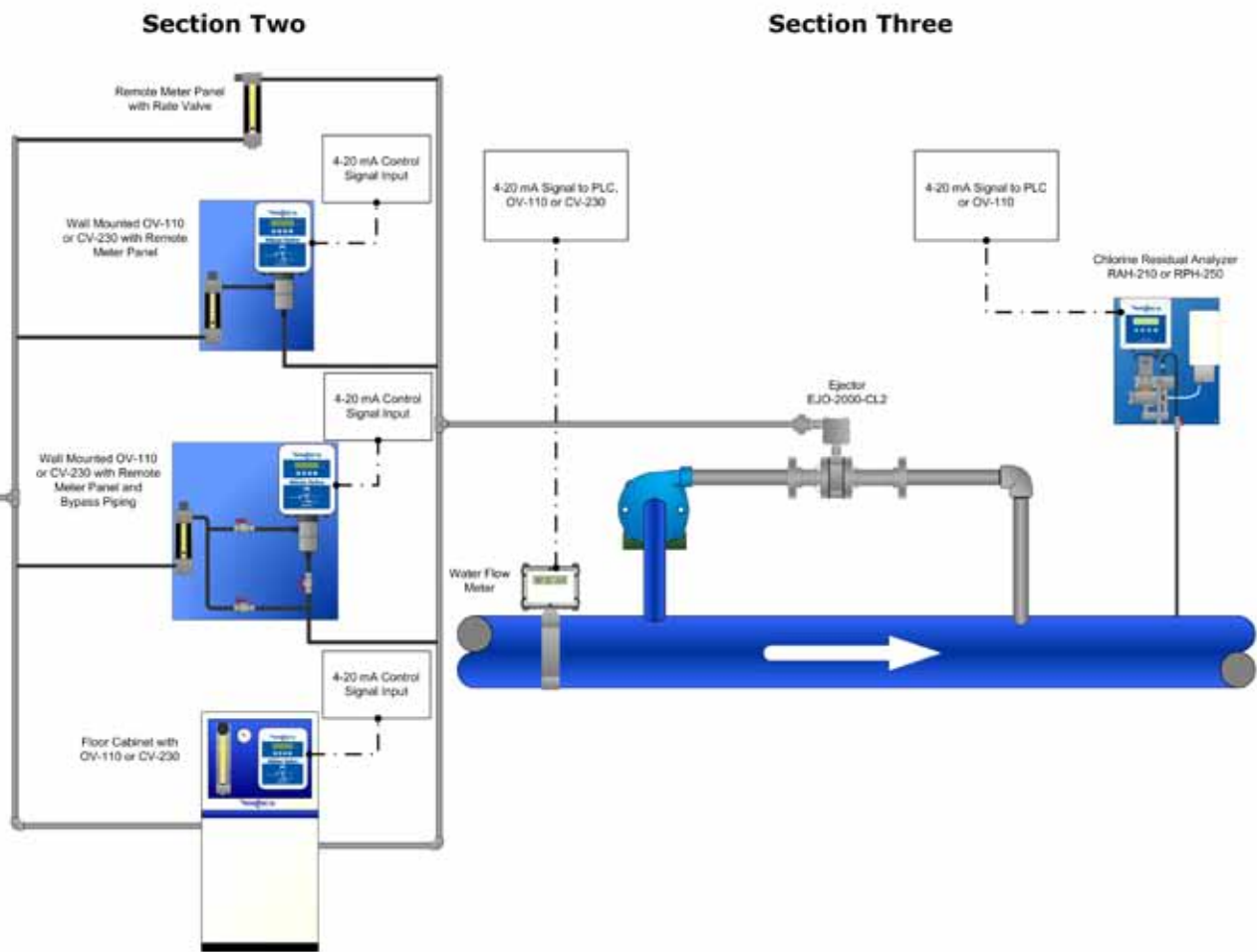

Figure 2: System Layout Options



Section 1 – Chlorine Supply: This section of the equipment consists of the chlorine containers, manifolds, vacuum regulators and changeover system.

- 1a. Ton Containers & Chlorine Manifolds:** NOTE: For more detailed technical information, please refer to the latest copy of Hydro Instruments TCM-DC design guide for ton container mounted manifolds.

Evaporation cooling limits the chlorine gas withdrawal rate for a single chlorine ton container to approximately 10 kg/hr (500 PPD). Therefore, a 40 kg/hr (2000 PPD) system should be designed so that four ton containers are feeding simultaneously. This can be accomplished by mounting a vacuum regulator on each ton container or by connecting four ton containers together with a pressurized manifold. Pressurized chlorine manifolds are used to collect chlorine gas from one or more chlorine ton containers. The manifold must trap and evaporate liquid chlorine to prevent it from entering and damaging the vacuum section of the equipment.

Figure 3: Chlorine Pressure Manifold

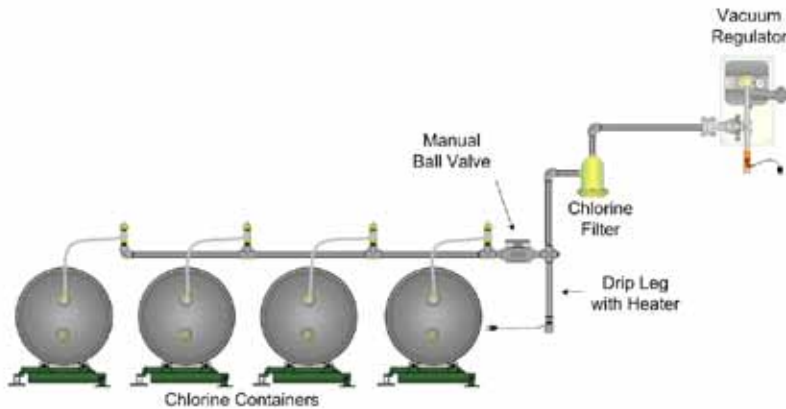

- 1b. Vacuum Regulators:** Chlorine gas enters the vacuum regulator under pressure. When the ejector is in operation it creates a vacuum (that vacuum extends to the rear cavity of the vacuum regulator) that causes the diaphragm assembly to press back against the spring loaded normally closed inlet valve, causing it to open and allow chlorine gas to flow in under vacuum conditions. When vacuum is lost for any reason, the inlet valve spring will close the valve and stop the flow of chlorine immediately.

Figure 4: Vacuum Regulator

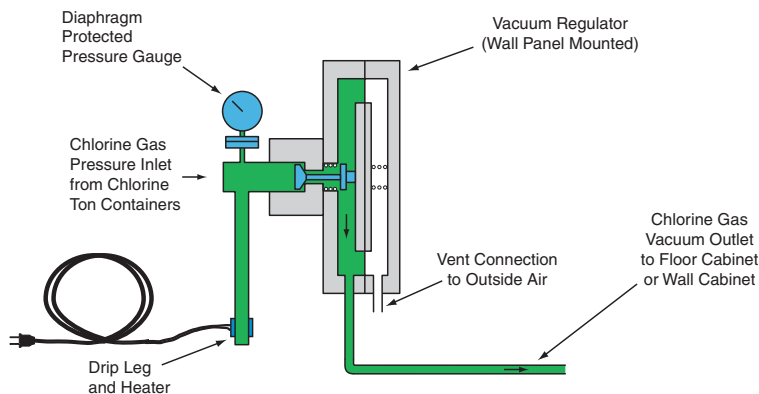

Vacuum Regulators

Hydro Instruments manufactures many different designs of vacuum regulators. Some of the most common configurations are shown in the following table. Other designs and configurations are available. Please review our website for more information.

750

- 10 kg/hr
- Optional flow meter
- Optional direct ton container mounting



750W-DL

- 10 kg/hr
- Optional flow meter
- Wall-mounted
- Optional drip leg and heater
- Diaphragm protected pressure gauge



SVR-500-CL2

- 10 kg/hr
- Integral vacuum switchover design
- Optional flow meter (5 kg/hr maximum)
- Wall-mounted
- Optional direct ton container mounting



VRH-2000-CL2

- 40 kg/hr
- Drip leg and heater
- 3/4" Steel Union Inlet
- 1" PVC Union Outlet
- Diaphragm protected pressure gauge
- Optional flow indication tube



VRH-8000-CL2

- 150 kg/hr
- Drip leg and heater
- 3/4" Steel Union Inlet
- Y-Strainer Inlet Filter
- 1.5" PVC Union Outlet
- Diaphragm protected pressure gauge
- Optional flow indication tube



VRH-10000-CL2

- 200 kg/hr
- Drip leg and heater
- 3/4" Steel Union Inlet
- Y-Strainer Inlet Filter
- 2" PVC Union Outlet
- Diaphragm protected pressure gauge
- Optional flow indication tube



1c. Changeover Equipment: Hydro Instruments offers three types of automatic changeover equipment. The function of this equipment is to automatically switch the chlorine gas supply to the standby manifold when the duty manifold containers are empty.

i. Vacuum Switchover by integral switchover vacuum regulators (Series 900): This equipment is only available for feed rates up to 10 kg/hr (500 PPD). The Series 900 vacuum regulator design offers automatic switchover based on the high vacuum condition that occurs when the duty chlorine containers are going empty. Once the duty containers are nearly empty, the vacuum level in the system will increase and cause the standby vacuum regulator to switch automatically into the feeding position. The advantage of this system is its simplicity and low cost.

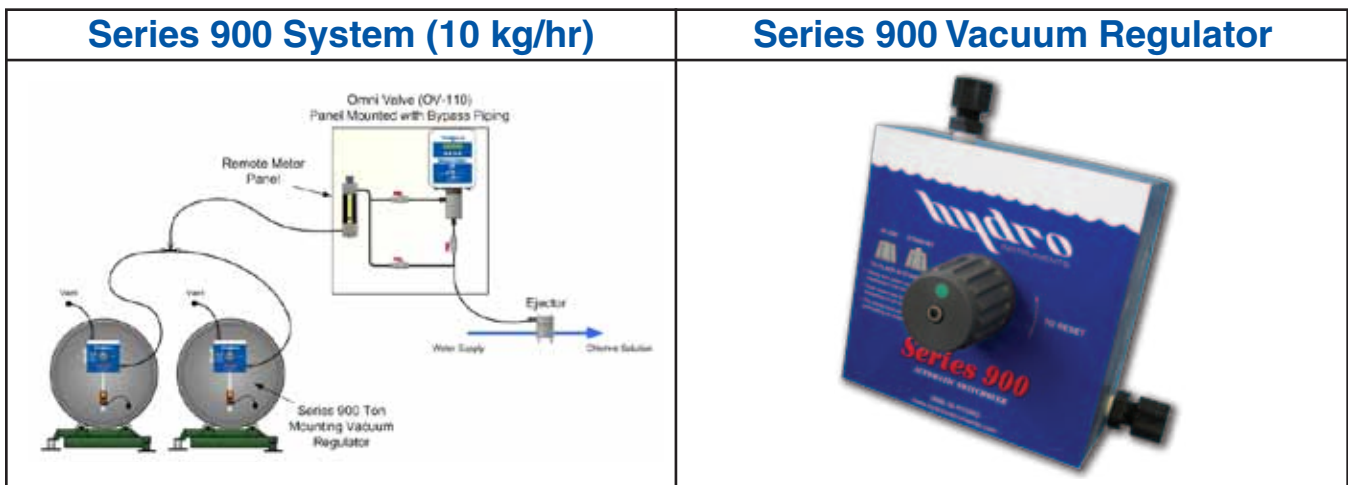

ii. Vacuum Switchover Modules: The operation of the vacuum switchover is also based on the rising vacuum level that accompanies the duty manifold ton containers going empty. The switchover module includes a spring loaded mechanism and two diaphragm assemblies. The advantage of this type of switchover mechanism is again the simplicity and relatively low cost.

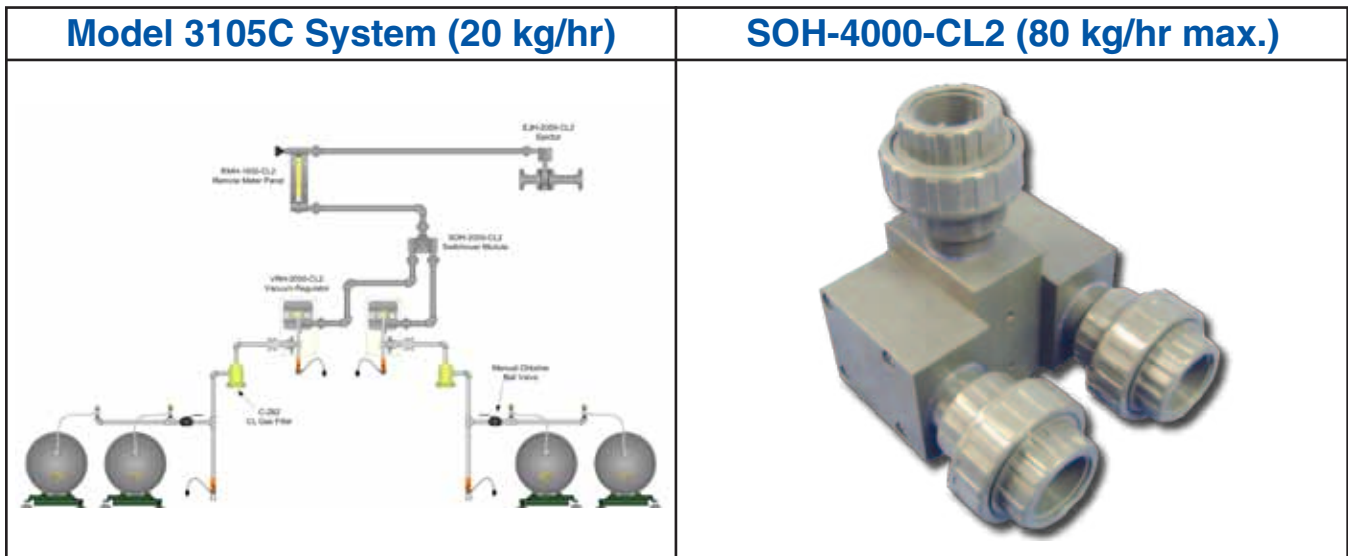

- iii. **Electronic Changeover System (Series CV-100):** The Hydro Instruments Series CV-100 automatic changeover system is designed to allow continuous supply of chlorine gas when using a duty/standby gas container system layout.

Figure 5: Series CV-100 Electronic Changeover System

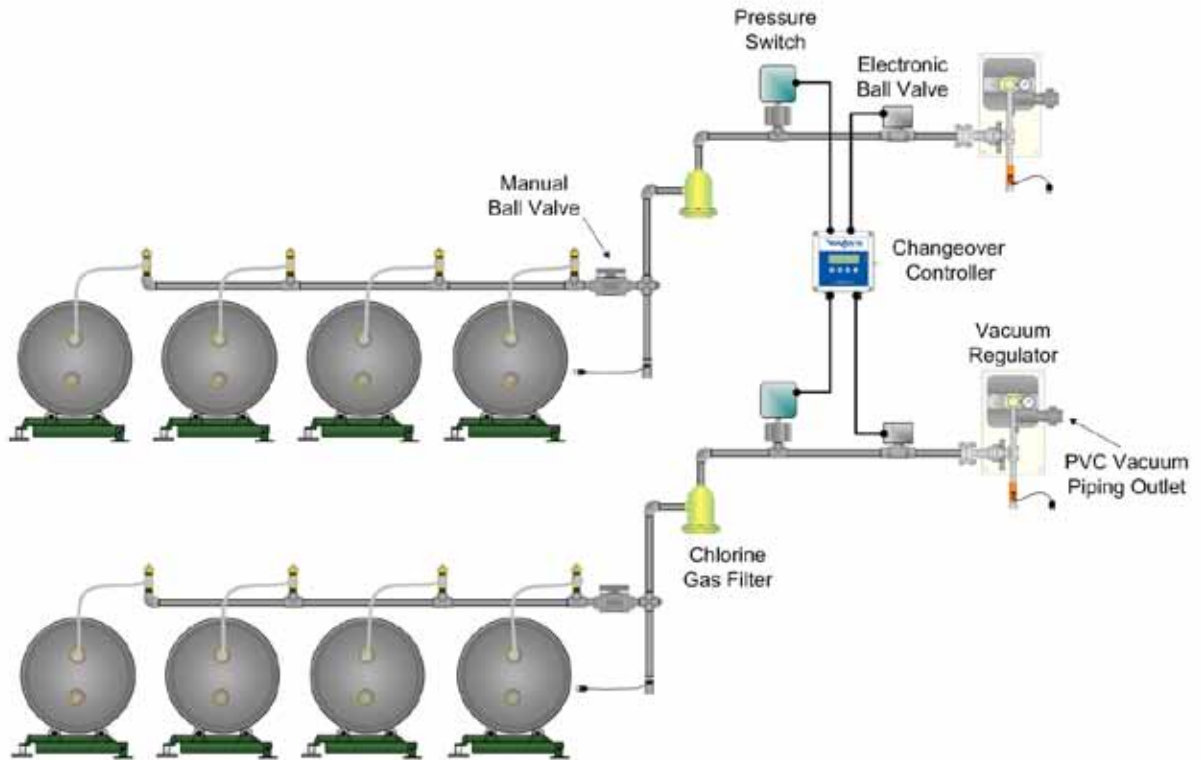

The system consists of a dedicated controller Model CV-100 designed for this application, two pressure switches, and two electronically actuated ball valves. In normal operation, the Model CV-100 controller will keep one of the ball valves open (duty) and the other closed (standby). Upon receiving a low pressure alarm relay signal indicating that the duty gas supply source is nearly depleted, the controller will close the duty ball valve and open the standby ball valve. After such a changeover event, the operator will be required to silence the changeover alarm, change the empty containers, and then acknowledge the container empty alarm.

The Model CV-100 controller also can be used to manually change which ball valve is in operation and to shut down both valves simultaneously. The Model CV-100 controller records the time that each ball valve has been in the duty condition and displays the time of day, day of the week and date of the year on the screen. LEDs on the controller also indicate operation and container empty status for both sides.

Section 2 – Feed Rate Control: This section of the equipment consists of a rotameter type flow meter, manual control valve, automatic control valves and other optional equipment.

Between the vacuum regulator and the ejector, the chlorine gas flows under vacuum. A chlorine gas flow meter is installed in this section of the system to give a visual indication of the chlorine gas feed rate. Each gas chlorination system will have a manual rate control valve installed after the flow meter tube. An automatic control valve can also be installed in between the flow meter tube and the ejector. Differential pressure regulators, vacuum gauges, vacuum alarms etc. are optional.

Figure 6: Feed Rate Control Equipment

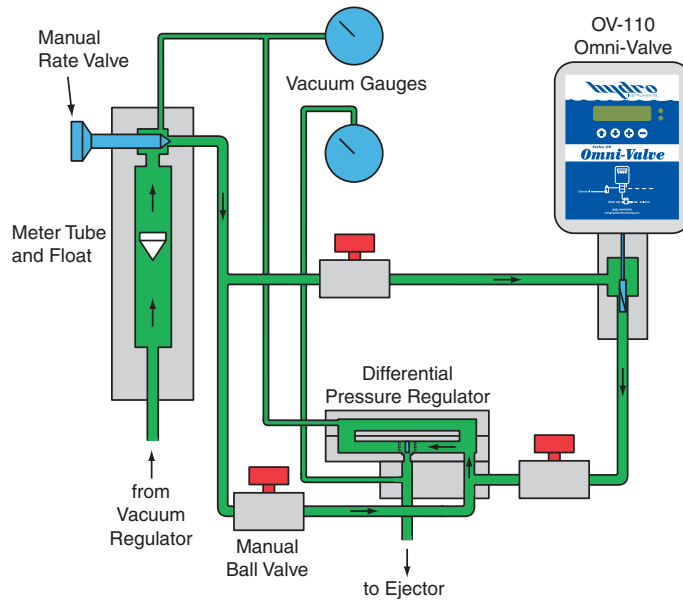

Control Type: The goal of a chlorine gas system is to inject chlorine into the water at a rate that will maintain a desired residual level in the treated process water. Therefore, as the water flow rate and the water quality change, the chlorine feed rate must also be adjusted accordingly to maintain the desired residual in the treated process water. Manual feed rate control can be used in systems where the process water flow and the water quality are both constant. If the water flow rate or water quality are variable, then it is best to use an automatic control system.

Figure 7: Automatic Control System (Compound Loop Control)

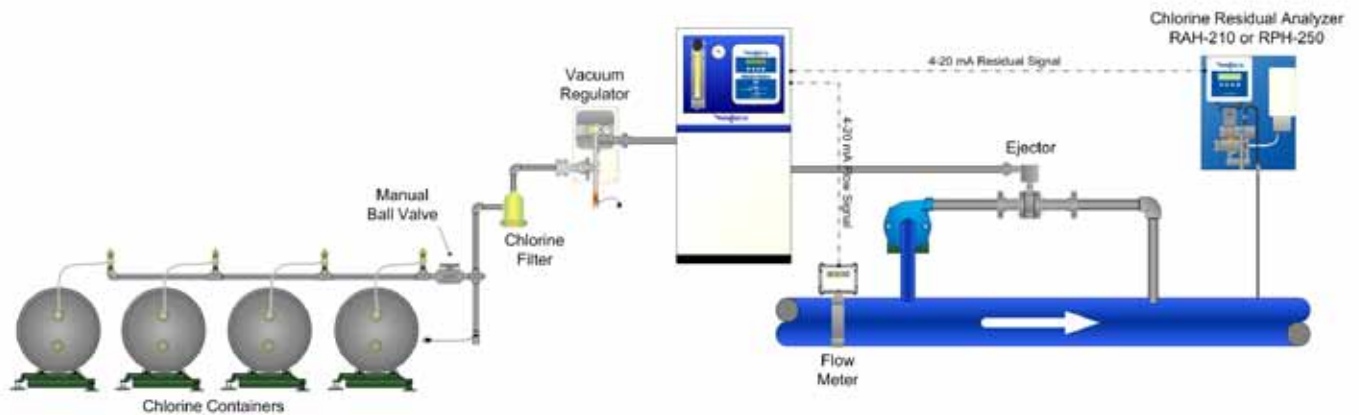

Automatic Control Valves

Hydro Instruments offers two different automatic control valves with the below listed general specifications. The Model 0V-110 offers complete Compound Loop (PID) control capabilities, while the CV-230 is more economical in price for applications that only require proportional control. Both valves use the same 10 point linearization process and automatic self calibration checking. These valves can be provided on wall panels or in floor cabinets.

CV-230

- Flow Pacing Control Only
- One 4-20mA Input Channel
- One Relay Alarm Output
- Two 4-20mA Output Channels
- 120 kg/hr maximum capacity (Cl₂)
- 2 line, 20 character LCD Display
- Linear Stepper Motor



OV-110

- Flow, Residual, Compound Loop & Step Feed
- Three 4-20mA Input Channels
- Four Relay Input Channels (step feed)
- One Relay Alarm Output
- Two 4-20mA Output Channels
- 120 kg/hr maximum capacity (Cl₂)
- 2 line, 20 character LCD Display
- Linear Stepper Motor



Wall Panel

Hydro Instruments offers prefabricated and tested wall panel mounted chlorine gas feed rate control panels in a variety of configurations. An example of the most common configuration with Model 0V-110 Omni-Valve, bypass piping with true union ball valves, and remote meter with rate valve is shown here. Such wall panels can be provided with vacuum gauges, differential pressure regulators, high/low vacuum alarms, etc.



Floor Cabinet

Hydro Instruments offers prefabricated and tested free standing floor cabinets with a variety of optional features to chose from. Floor cabinets offer a convenient and aesthetic appearance for mounting the control and indication equipment for each chlorine gas feed point. Floor cabinets house the automatic control valve (CV-230 or OV-110), the flow meter tube and manual rate valve, and at least one vacuum gauge with diaphragm protection. Optional equipment includes a second vacuum gauge, high/low vacuum alarm, and differential pressure regulator.



Differential Pressure Regulators

Recommended for feed rates 40 kg/hr and higher
 Not necessary for 10 kg/hr and below
 Used for stabilizing rotameter indicator float

Section 3 – Ejectors: This section creates the vacuum that operates the system and mixes the chlorine gas with the water.

High velocity water flow through the ejector venturi nozzle creates the vacuum that operates the gas chlorination system. Chlorine gas feed is stopped by stopping the water flow to the ejector. When the system is not operating and there is no water flow through the ejector nozzle, there will be no vacuum. Each ejector includes at least one check valve to prevent water from flowing back into the gas chlorination equipment when the system is turned off. Hydro Instruments manufactures a variety of different ejector designs. Refer to the nozzle performance charts and curves that can be found in the Hydro Instruments instruction manuals to consider the water flow and pressure requirements for each ejector. In general, several nozzles are available for each ejector. A list of common ejectors is given here.

EJH-142-CL2, EJH-242-CL2, EJH-542-CL2

- 10 kg/hr Maximum Capacity
- 3/4" NPT (2 kg/hr)
- 1 1/4" NPT (5 & 10 kg/hr)
- 10 kg/cm² (standard b.p.)
- 20 kg/cm² (high b.p. option)
- Check Valve without diaphragm



EJ-1000, EJ-2000, EJ-5000

- 10 kg/hr Maximum Capacity
- 3/4" NPT (2 kg/hr)
- 1 1/4" NPT (5 & 10 kg/hr)
- Double Check Valve option available
- 10 kg/cm² (standard b.p.)
- 20 kg/cm² (high b.p. option)
- Diaphragm Check Valve



EJH-2000-CL2 and EJH-3000-CL2

- 120 kg/hr Maximum Capacity
- 2" Flanged and 3" Flanged sizes
- 10 kg/cm² (maximum b.p.)
- Diaphragm Check Valve

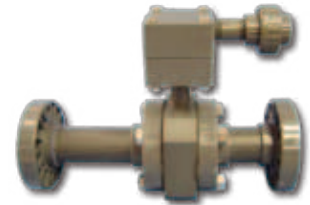

The water exiting the ejector contains highly concentrated chlorine solution. Hydro Instruments manufactures a variety of diffusers and corporation stop assemblies that can be used to conveniently and safely inject this solution into the process stream. Secondary check valves are also available for greater protection against water backflow during system stop conditions.

Open Channel Diffusers

Provides more effective mixing in open channels and contact chambers 1/2" through 4" pipe diameter. Every unit is custom-built: pipe size, length, hole diameter, hole quantity, hole spacing and inlet connection.

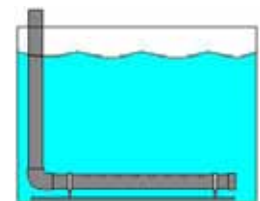

Spray Diffusers and Corporation Stops

Prevents corrosion of the solution & process piping and provides better mixing in the process line. Corporation stops are designed to allow removal of the diffuser while the process pipe remains pressurized. Available in a range of sizes and materials.

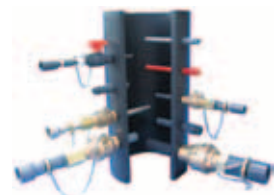

Gas Leak Detectors

Hydro Instruments manufactures two series of gas leak detection equipment. Both series use the same sensors and therefore offer detection of the same set of gases. Sensors are available for Cl_2 , SO_2 , NH_3 , O_3 , ClO_2 , H_2S , CO_2 , H_2 , O_2 , NO , NO_2 , & HCl . The general specifications are shown here below.

GA-170

- 1 to 4 sensors per monitor
- 2 line, 16 character display
- Integral 90 dB audible alarm
- Optional battery backup
- 6 adjustable relay outputs
- 2 LED indicators per sensor
- RS-232 and 4-20mA outputs



GA-171

- 1 to 2 sensors per monitor
- 2 line, 16 character display
- 1 adjustable common relay output
- 2 LED indicators per sensor
- RS-232 and 4-20mA outputs



Residual Analyzers

Hydro Instruments produces two series of residual analyzers for online measurement. Both instruments utilize the amperometric method of measurement. The Series RAH-210 incorporates an open flow cell design with large electrode surface area and continuous motor driven cleaning for rugged operation. The Series RPH-250 incorporates a semipermeable membrane and electrolyte design.

RAH-210

- Free Chlorine, Total Chlorine, & ClO_2
- Continuous Self Cleaning
- PID controller included
- One 4-20mA input channel
- Two 4-20mA output channels
- One alarm relay output
- 2 line, 20 character display
- 2 LED indicators
- RS-232 output
- Temperature Sensor
- Optional pH probe
- Optional Buffer Chemical Feed Systems
- Optional pH Compensation in software



RPH-250

- Free Chlorine & ClO_2
- PID controller included
- One 4-20mA input channel
- Two 4-20mA output channels
- One alarm relay output
- 2 line, 20 character display
- 2 LED indicators
- RS-232 output
- Temperature Sensor
- Optional pH probe
- Optional pH Compensation in software



Additional Gas Chlorination Equipment

Chlorine Service Ball Valves

- Manual and electronic with a range of connection sizes. Teflon seals and Carbon Steel housings. Optional Monel or Hastelloy C ball and stem.



Isolation Valve Assemblies

- Eliminate the stress on flexible connectors during cylinder changes. Increase the safety and convenience of changing chlorine containers.

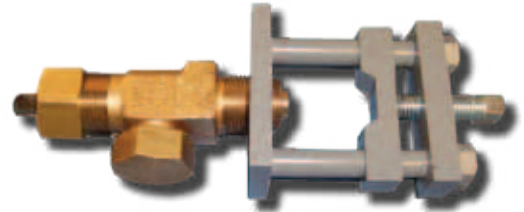

Vacuum Monitor

- Continuously monitor the chlorine gas vacuum level with digital display. Adjustable high and low alarm relays. Specifically designed for chlorine gas application.

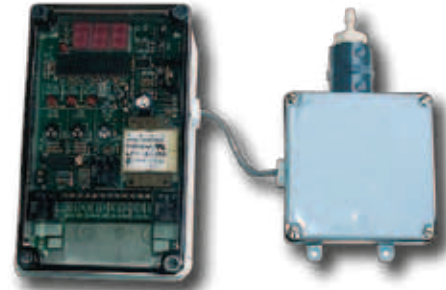

Chlorine Container Scales

- Used for monitoring and recording chlorine supply and usage. Electronic and hydraulic scales are available from Hydro Instruments in a variety of configurations. Scale sets are available for weighing the contents of one, two or more chlorine containers simultaneously.



Pressure Reducing Valve

- The Hydro Instruments Series PRV-71H Pressure Reducing Valve is used to reduce and control the gas pressure downstream of the valve. The PRV-71H is designed for chlorine or sulfur dioxide gas service.



Chlorine Leak Absorption Systems

The chlorine scrubber system operation is activated by an alarm relay signal from a gas leak detector. Chlorine storage room air is drawn into the scrubber system where the chlorine is chemically extracted before exhausting the cleaned air to the outside environment. Chlorine scrubber systems are available from Hydro Instruments and our sales representatives in a variety of configurations and sizes.



SINGLE STAGE SCRUBBER

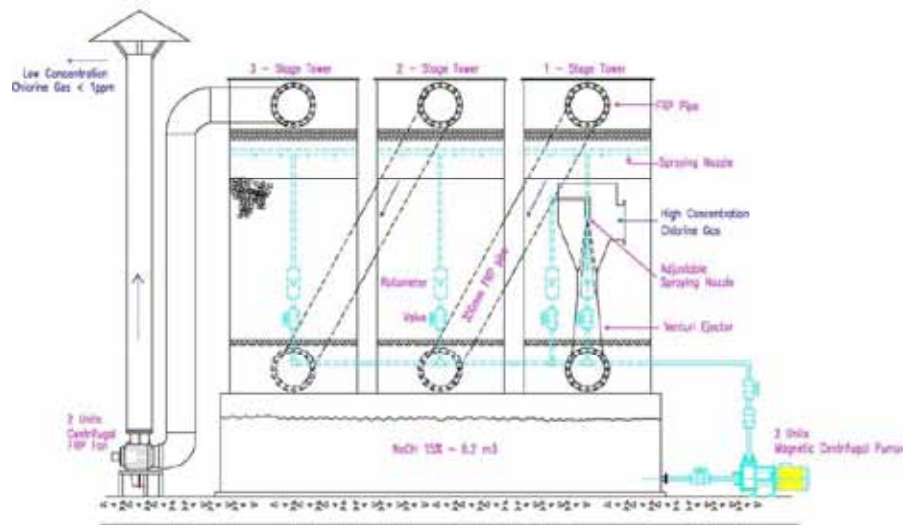

3 STAGE SCRUBBER

Emergency Shut-Off Systems

These systems are activated by an alarm relay signal from a gas leak detector. A valve closure actuator (shut-off device) is mounted directly on the chlorine container valve. In the event of a leak, the device will close all of the chlorine container valves immediately to stop the leak. Emergency shut-off systems are available from Hydro Instruments and our sales representatives in a variety of configurations and sizes.

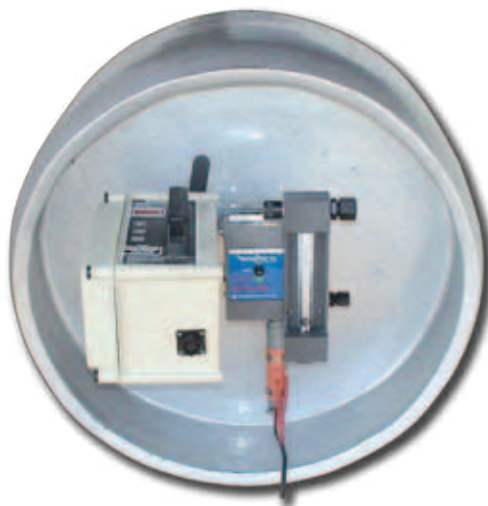



Contact us:

Hydro Instruments
600 Emlen Way
P.O. Box 387
Telford, PA 18969 USA
TEL: 215-799-0980
FAX: 215-799-0984
Website: <http://www.hydroinstruments.com/>



USA & Canada

E-mail: sales@hydroinstruments.com

International Sales

E-mail: intsales@hydroinstruments.com

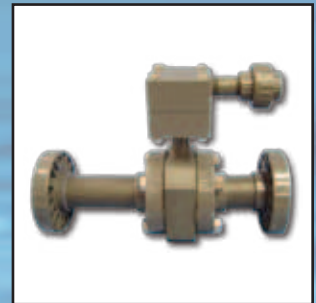

Represented by:

